

DR()P

4 - 9

DR()P
LINE

10 - 35

DR()P
FIELD

38 - 47

TINY
DR()P

48 - 55

Driver

56 - 57

Legende
Signs and symbols

60

DRÖP

Unsere Leidenschaft für Licht ...

... treibt uns ständig an, die besten Lösungen zu finden und umzusetzen. So konnten wir bereits in der Vergangenheit viele außergewöhnliche Ideen in den unterschiedlichsten Projekten realisieren.

Das Zeitalter der LED, das inzwischen in allen Bereichen unseres Lebens angekommen ist, eröffnet nun weitere, unzählige Möglichkeiten sich vom Medium Licht inspirieren zu lassen.

Ganz im Zeichen des Fortschritts und der Weiterentwicklung haben wir in Zusammenarbeit mit einem renommierten österreichischen Ingenieurbüro unsere drop Reflektoren entwickelt. Dabei handelt es sich um Freiform-Facetten Reflektoren mit zwei unterschiedlichen Ausstrahlwinkeln und perfekter Blendungsbegrenzung.

Mit unserem drop Reflektor ist es uns gelungen, eine neue Leuchtenserie zu entwickeln, die in allen Bereichen des Alltags Anwendung findet. Im Bürobereich überzeugt sie durch die hervorragende Ausblendung von Bildschirmarbeitsplätzen und in privaten Wohnbereichen besticht sie zugleich durch ihr Design sowie die kompakte Bauform.

Der drop Reflektor kann in linearen Anwendungen, in Lichtfeldern, aber auch als Einzellichtpunkt verbaut werden, wodurch sich vielfältige Gestaltungsmöglichkeiten eröffnen.



Our passion for light. . .

... drives us constantly to find and implement the best solutions. Thus, we were able to implement many extraordinary ideas in the most diverse projects already in the past.

The age of LED, which has arrived in all the areas of our life, opens up numerous further possibilities of being inspired by the medium of light.

As a token of progress and further development, we have developed our drop reflectors in collaboration with a renowned Austrian engineering company. It is a free-form facet reflector with two different radiation angles and perfect glare control.

With our drop reflector we have been able to develop a new light series, which finds application in all areas of daily life. In the office area, it impresses with excellent glare limitation for computer workplaces and in private residential areas it entices with its design as well as compact structure.

The drop reflector can be installed in linear applications, in light fields, but also as single light points, which open up a multiplicity of design options.



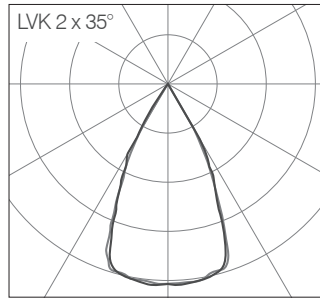
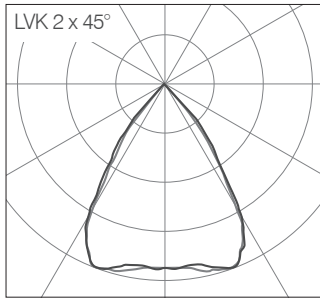

Reflektoren

Der drop Reflektor ist ein Freiform-Facetten Reflektor aus Kunststoff, der im Spritzgussverfahren hergestellt wird. Die hochreflektierende Oberfläche aus Aluminium wird als Bedampfung aufgetragen. Für unsere "black-gold edition" werden die drop Reflektoren mit Echtgold beschichtet. Durch die Verwendung des Goldreflektors wird die Lichtfarbe der LED um 300 K reduziert.

Für vielseitige Einsatzmöglichkeiten stehen die Reflektoren in zwei unterschiedlichen Ausstrahlwinkeln zur Verfügung. Bei den im Text angeführten Ausstrahlwinkeln handelt es sich um den Zehntelwinkel.

Der Reflektor mit 2 x 45° hat einen Wirkungsgrad von 96%, wodurch fast die gesamte Systemleistung der LED auch als Nutzlichtstrom zur Verfügung steht. Der Wirkungsgrad des 2 x 35° Reflektors liegt mit 87% nur unwesentlich darunter. Dies ergibt sich durch den engeren Ausstrahlwinkel und die damit verbundene, noch bessere Ausblendung.

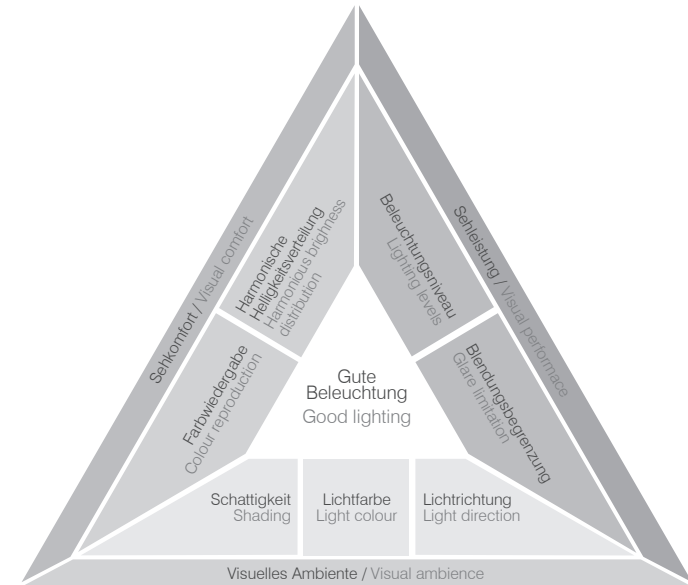

Reflectores

The drop reflector is a freeform faceted reflector made of plastic which is manufactured in the injection moulding process. The highly reflective surface is achieved by metallization with aluminium. For our "black-gold edition" the drop reflectors are coated with pure gold. By using the gold reflector, the CCT of the LED gets reduced up to 300 K.

For versatile use options, the reflectors are available in two different radiation angles. The radiation angles listed in the text are the tenth angles.

As shown in the polar diagrams above, the 2x45° reflector has a degree of efficacy of 96%. So almost the entire light emitted by LED PCB can be used. With 87% the degree of efficacy of the 2x35° reflector is only slightly less in comparison.





Reflexblendung: Je nach Art der Bildschirmklasse muss die mittlere Leuchtdichte von Leuchten, die sich im Bildschirm spiegeln können, ab dem Grenzausstrahlwinkel von $\gamma = 65^\circ$ auf 200 cd/m^2 bzw. 1.000 cd/m^2 begrenzt werden, um störende Reflexionen zu vermeiden.

Glare by reflection: Depending of the type of class screen the average luminance of luminaires which can be reflected on the screen has to be limited from critical radiation angle of $\gamma = 65^\circ$ to 200 cd/m^2 respectively 1000 cd/m^2 to avoid disturbing glare.

$$UGR = 8 \log \frac{0,25}{L_b} \sum \frac{L^2 \Omega}{p^2}$$

Blendung und Blendungsbegrenzung

In bestimmten Arbeitsbereichen spielt die richtige Blendungsbegrenzung eine sehr große Rolle. Um Fehlern, Ermüdung und Unfällen zu entgehen, ist es wichtig, Blendung zu vermeiden. Grundsätzlich unterscheidet man zwischen Direkt- und Reflexblendung. Die Ursache für direkte Blendung können nicht entblendete Leuchten und Flächen mit großer Leuchtdichte sein. Die Reflexblendung kann durch spiegelnde Oberflächen, falsche Anordnung der Leuchten, oder auch schlecht positionierte Arbeitsplätze verursacht werden.

Die europäische Norm EN 12464 regelt die Beleuchtung von Arbeitsstätten im Innenraum. Dabei wird das UGR-Verfahren (unified glare rating) zur Beurteilung der psychologischen Blendung verwendet. Die UGR Blendformel berücksichtigt alle Leuchten der Anlage, die zum Blendeindruck beitragen, sowie die Helligkeit der Wände und Decken.

Mit den drop Reflektoren ergeben sich UGR-Grenzwerte < 18 für Sehaufgaben wie Lesen, Schreiben, Besprechung, Bildschirmarbeitsplätze (BAP) und Schulen. Also allen Tätigkeiten, für die in der Norm EN 12464 UGR-Grenzwerte < 19 vorgeschrieben werden.

Glare and glare limitation

In certain work areas correct glare limitation plays a very crucial role. It is important to avoid glare in order to prevent faults, fatigue and accidents. In principle one differentiates between direct and glare by reflection. The cause of direct glare can be lights without glare control systems and surfaces with high light intensity. Glare by reflection can be caused by reflecting surfaces, improper arrangement of lights, or also poorly positioned workplaces.

The European standard EN 12464 regulates the illumination of workplaces. Here, the UGR method (unified glare rating) for assessing the glare is used. The UGR glare formula takes into consideration all the lights that contribute to the glare impression, as well as the brightness of the walls and ceilings.

The drop reflectors achieve UGR values < 18 for tasks like reading, writing, meetings, computer workstations and educational facilities. In other words, all activities for which values < 19 are regulated in the EN 12464.

LED Platinen + tuneable white

Für unsere drop Serie wurden LED-Platinen entwickelt, die speziell auf die Reflektoren abgestimmt wurden. Jeder Lichtpunkt ist mit Mid-Power-LEDs versehen, die sowohl in Bezug auf Effizienz als auch auf Farbwiedergabe dem letzten Stand der Technik entsprechen und eine Lebensdauer von mindestens 50.000 Stunden erreichen. Die Bestückung der Platinen ist in den gängigen Lichtfarben 2700 K, 3000 K und 4000 K möglich.

LED Leuchten mit der Bestückung in tuneable white - 2700 K und 5700 K, der adaptiven Lichtfarbe mit dynamischer Farbtemperaturanpassung, weist den Weg in die Zukunft der benutzerorientierten, flexiblen Lichtlösungen. Kombiniert mit der passenden tageslichtorientierten Lichtsteuerung wird damit ein höheres Wohlbefinden durch die abgestimmte Farbtemperatur des Kunstlichts erzielt, da Studien zufolge, dadurch der Melatoninhaushalt positiv beeinflusst wird.

LED PCB + tuneable white

LED PCB were developed for our drop series which are designed especially for the reflectors. Each light point is fitted with mid-power-LEDs, which correspond to the latest technology both with reference to efficiency as well as from the perspective of colour reproduction. They achieve a life-span of minimum 50,000 hours. The PCB can be in the common CCT 2700 K, 3000 K and 4000 K.

Light fixtures fitted in tuneable white - 2700K and 5700K – the adaptive light colour with dynamic CCT adjustment gives an indication of the user-oriented, flexible light solutions of the future. Combined with the matching daylight-oriented light control, a higher feel-good factor is achieved through the CCT of the artificial light. According to several studies, all this influences the melatonin household in a positive way.



tuneable white
5700 K



Energieökonomie

Mit einer Effizienz von bis zu 150 lm/W und einem Wirkungsgrad der Leuchte von bis zu 96%, zeichnet sich unsere drop Serie vor allem durch eine sehr geringe Energieaufnahme aus.

Die hervorragende Energieeffizienz der verbauten LEDs verringert nicht nur die jährlichen Energiekosten, sondern es entfallen, dank der wesentlich längeren Lebensdauer der LEDs gegenüber beispielsweise der Halogen-Metall dampflampe, auch die Wartungskosten. Zusätzlich reduziert sich auch die Wärmeabgabe der Beleuchtungsanlage und die damit verbundenen Kosten für Kühlung.

Lichtlösungen wie diese nehmen also direkten Einfluss auf die operativen Kosten. Die Investition in die LED als Lichtquelle spart so langfristig Kosten und schont die Umwelt.

Das ist Energieökonomie in ihrer schönsten Form.

Environmental compliance

With an efficiency of up to 150 lm/W and a degree of efficacy of light of up to 96%, our drop series distinguishes itself most of all through a very low energy input.

The excellent energy efficiency of the installed LEDs reduces not only the annual energy costs, but also does away with maintenance costs, thanks to the essentially longer life-span of LEDs as compared to e.g., metal halide lamp. Additionally, the heat output of the lighting system is a lot lower and therefore, the cooling costs are also reduced.

Light solutions like this have a direct bearing on the operative costs. Investment in LED as light source saves long-term costs and protects the environment.

This is energy economy in its most beautiful way.

tuneable white
2700 K

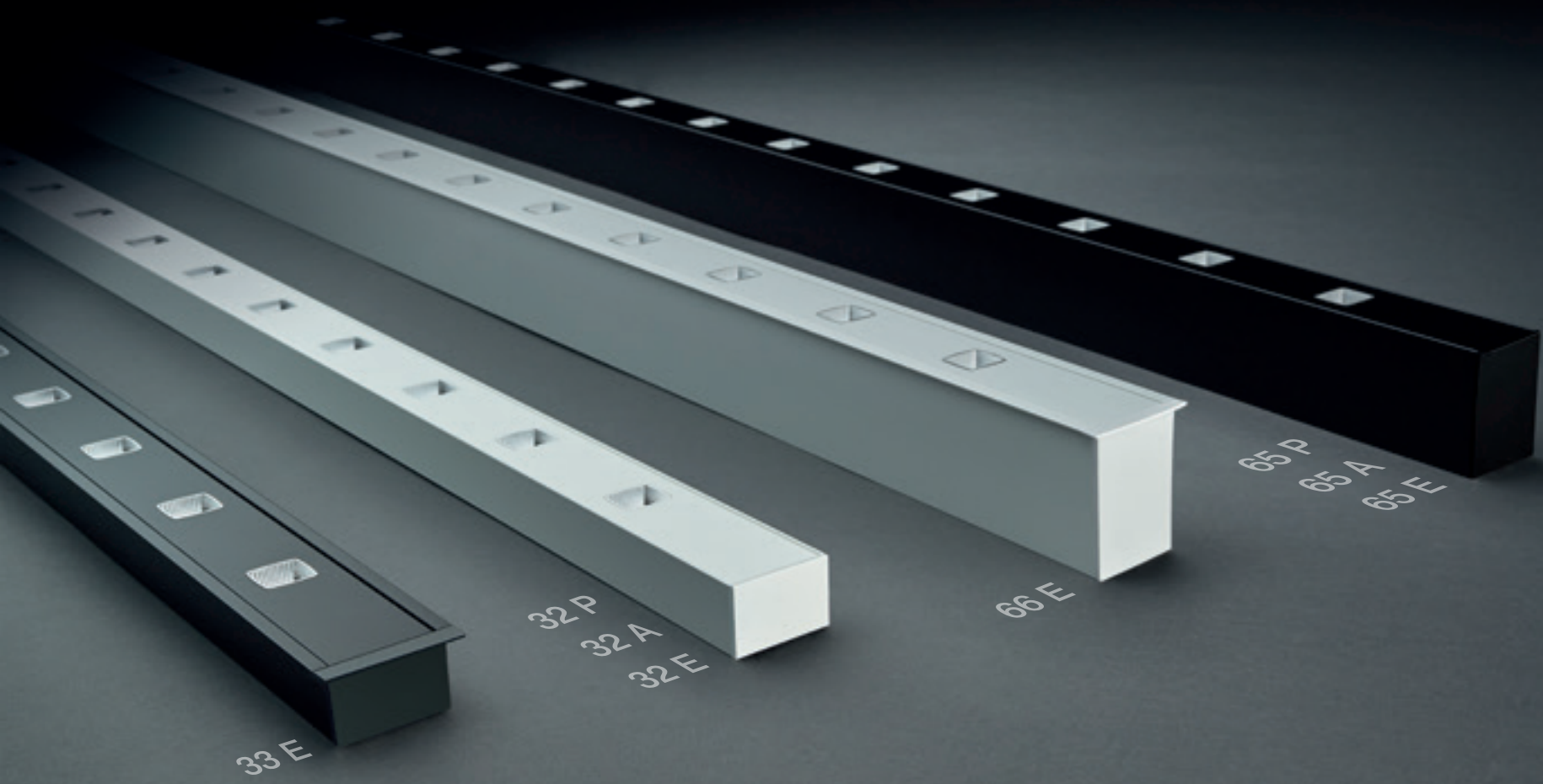

33 E

32 P
32 A
32 E

66 E

65 P
65 A
65 E

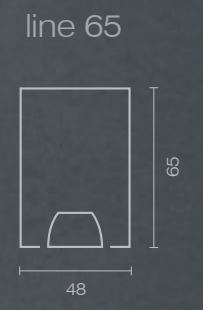
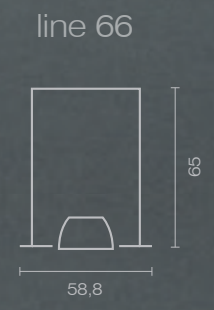
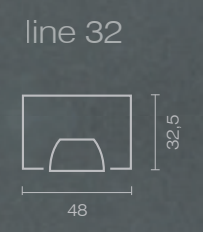
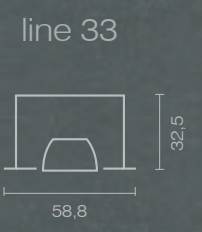

Lineare Anwendungen

Linear applications

Unendliche Möglichkeiten

Die große Vielseitigkeit unserer drop serie zeigt sich anhand der zahlreichen Konfigurationsmöglichkeiten. Insgesamt stehen vier verschiedene Profiltypen zur Verfügung, die mit den drop Reflektoren bestückt werden können.

Mit höchster Lichtleistung, bei gleichzeitig konsequent reduziertem Energiebedarf, besticht unsere drop line nicht nur durch ihr ansprechendes Design. Hinter dem schlichten Leuchtenkörper aus Aluminium und dem drop Reflektor, sorgen äußerst effiziente Mid-Power-LEDs für eine hervorragende Lichtausbeute.

Unlimited possibilities

The versatility of our drop series is evident from the numerous configuration options it offers. On the whole, four different profile types are available, which can be equipped with the drop reflectors.

With maximum light output at simultaneously consistent reduced energy demand, our drop line entices not just with its impressive design. Behind the modest light body made of aluminium and the drop reflector, the extremely efficient mid-power-LEDs ensure excellent luminous efficiency.



Pendelleuchten

Pendant luminaire

Klares Design, das schwebt

Mit den drop line Pendelleuchten bringen Sie die Vorteile der drop Reflektoren schwebend zur Geltung. Das klare und geradlinige Design sorgt neben perfekten Lichtverhältnissen für ein optisches Highlight in jedem Raum.

Die nachstehenden drop lines sind Leuchten mit vordefinierten Längen der unterschiedlichen Profiltypen inkl. allem notwendigen Zubehör. Wie gewohnt, sind alle Profile in Aluminium eloxiert, weiß oder schwarz erhältlich. Andere Farben der RAL oder NCS-Farbpalette sind selbstverständlich ebenfalls möglich.

Floating design

With the pendant luminaires of the drop line series, you enjoy the advantages of the drop reflectors in floating form. The clear and linear design ensures an optical highlight in each room besides perfect lighting conditions.

The following drop lines are luminaires with fixed lengths of different profile types including all the necessary accessories. As usual, all the profiles are available in anodized aluminium, white or black. Various colours out of the RAL and NCS colour range on request.

Pendel
Pendant

65 P

- drop Reflektoren 45° bzw. 35°
Aluminium bedampft laut angegebener Stückzahl (#DOT)
Echtgold beschichtete Reflektoren 45° auf Anfrage möglich
drop reflectors 45° or 35° aluminium metalised according to the specified number of units (#DOT)
gold coated reflectors 45° on request
- Aluminiumprofil natureloxiert in angeführter Länge
Standard Oberflächen siehe Seite 60
Anodised aluminium profile in the specified length
for colour options refer to page 60
- LED Platine – Mid-Power-LEDs
Lichtfarbe nach Wahl
LED PCB – Mid-Power-LEDs
please specify CCT when ordering
- Enddeckel
Seileinspeisung mit quadratischem Baldachin
Seilabhängung, L = 2.000 mm, stufenlos höhenverstellbar
End caps
Cable power supply with square base plate
Cable suspension, L = 2.000 mm, height adjustable
- Entsprechender Konverter im Leuchtenprofil integriert
Matching driver integrated into profile
- ¹ DALI dimmbar = code + D
tuneable white DALI dimmbar
¹ DALI dimmable = code + D
tuneable white DALI dimmable

CE  IP20

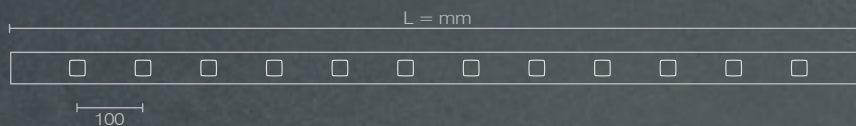

65 P

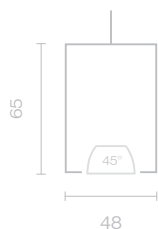

45°	K	L=mm	#DOT	W	lm	CODE ¹
3000		1.010	9	12	1.800	6565P0232
		1.310	12	16	2.400	6565P0332
		1.610	15	20	3.000	6565P0432
		1.910	18	24	3.600	6565P0532
4000		1.010	9	12	1.935	6565P0242
		1.310	12	16	2.580	6565P0342
		1.610	15	20	3.225	6565P0442
		1.910	18	24	3.870	6565P0542
tuneable white 2700 / 5700		1.310	12	8 / 8	1.020 / 1.140	6565P03T2
		1.610	15	10 / 10	1.275 / 1.425	6565P04T2
		1.910	18	12 / 12	1.530 / 1.710	6565P05T2

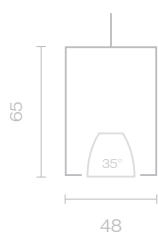

35°	K	L=mm	#DOT	W	lm	CODE ¹
3000		1.010	9	12	1.800	6565P0231
		1.310	12	16	2.400	6565P0331
		1.610	15	20	3.000	6565P0431
		1.910	18	24	3.600	6565P0531
4000		1.010	9	12	1.935	6565P0241
		1.310	12	16	2.580	6565P0341
		1.610	15	20	3.225	6565P0441
		1.910	18	24	3.870	6565P0541
tuneable white 2700 / 5700		1.310	12	8 / 8	1.020 / 1.140	6565P03T1
		1.610	15	10 / 10	1.275 / 1.425	6565P04T1
		1.910	18	12 / 12	1.530 / 1.710	6565P05T1

Für Lichtfarbe 2700 K bitte die vorletzte Stelle der Artikelnummer durch 2 ersetzen
For CCT 2700 K please replace the penultimate digit of the item number by 2

32 P

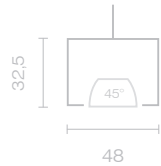

**45°
direct**

K	L=mm	#DOT	W	lm	CODE¹
3000	1.300	12	16	2.400	6532P0332
	1.550	18	24	3.600	6532P0432
	1.800	21	28	4.200	6532P0532
4000	1.300	12	16	2.580	6532P0342
	1.550	18	24	3.870	6532P0442
	1.800	21	28	4.515	6532P0542
tuneable white 2700 / 5700	1.300	12	8 / 8	1.020 / 1.140	6532P03T2
	1.550	18	12 / 12	1.530 / 1.710	6532P04T2
	1.800	21	14 / 14	1.785 / 1.995	6532P05T2

**45°
direct / indirect**

K	L=mm	#DOT	W	lm direct	lm indirect	CODE¹
3000	1.300	12	20	2.400	1.200	6532P1332
	1.550	18	32	3.600	1.200	6532P1432
	1.800	21	36	4.200	1.200	6532P1532
4000	1.300	12	20	2.580	1.290	6532P1342
	1.550	18	32	3.870	1.290	6532P1442
	1.800	21	36	4.515	1.290	6532P1542
tuneable white 2700 / 5700	1.300	12	20	1.020 / 1.140	1.290	6532P13T2
	1.550	18	32	1.530 / 1.710	1.290	6532P14T2
	1.800	21	36	1.785 / 1.995	1.290	6532P15T2

Für Lichtfarbe 2700 K bitte die vorletzte Stelle der Artikelnummer durch 2 ersetzen
For CCT 2700 K please replace the penultimate digit of the item number by 2



Pendel
Pendant

32 P

- drop Reflektoren 45° Aluminium bedampft laut angegebener Stückzahl (#DOT)
Echtgold beschichtete Reflektoren 45° auf Anfrage möglich
drop reflectors 45° aluminium metalised according to the specified number of units (#DOT)
gold coated reflectors 45° on request
- Aluminiumprofil natureloxiert in angeführter Länge
Standard Oberflächen siehe Seite 60
Anodised aluminium profile in the specified length
for colour options refer to page 60
- LED Platine – Mid-Power-LEDs
Lichtfarbe nach Wahl
indirekt Platine bei tuneable white = 4000 K
LED PCB – Mid-Power-LEDs
please specify CCT when ordering
indirect PCB tuneable white = 4000 K
- Enddeckel
Seileinspeisung mit quadratischem Baldachin
Seilabhängung, L = 2.000 mm, stufenlos höhenverstellbar
End caps
Cable power supply with square base plate
Cable suspension, L = 2.000 mm, height adjustable
- Entsprechender Konverter im Blindteil der Leuchte integriert
Matching driver integrated into profil behind blind part
- ¹ DALI dimmbar = code + D
tuneable white DALI dimmbar
¹ DALI dimmable = code + D
tuneable white DALI dimmable

CE  IP20

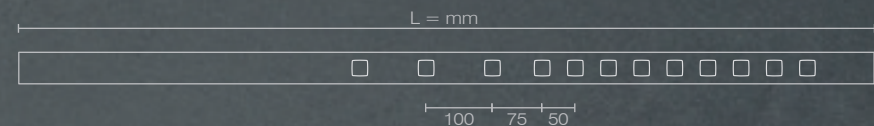

Pendel
Pendant

32 P+

- drop Reflektoren 45° Aluminium bedampft laut angegebener Stückzahl (#DOT)
Echtgold beschichtete Reflektoren 45° auf Anfrage möglich
drop reflectors 45° aluminium metalised according to the specified number of units (#DOT)
gold coated reflectors 45° on request
- Aluminiumprofil natureloxiert in angeführter Länge
Standard Oberflächen siehe Seite 60
Anodised aluminium profile in the specified length
for colour options refer to page 60
- LED Platine – Mid-Power-LEDs
Lichtfarbe nach Wahl
indirekt Platine bei tuneable white = 4000 K
LED PCB – Mid-Power-LEDs
please specify CCT when ordering
indirect PCB tuneable white = 4000 K
- Enddeckel
Seileinspeisung mit Driverbox, Seilabhängung, L = 2.000 mm, stufenlos höhenverstellbar
End caps
Cable power supply with driverbox
Cable suspension, L = 2.000 mm, height adjustable
- Entsprechender Konverter in Driverbox integriert
Matching driver integrated in driverbox
- † DALI dimmbar = code + D
tuneable white DALI dimmbar
† DALI dimmable = code + D
tuneable white DALI dimmable

CE  IP20

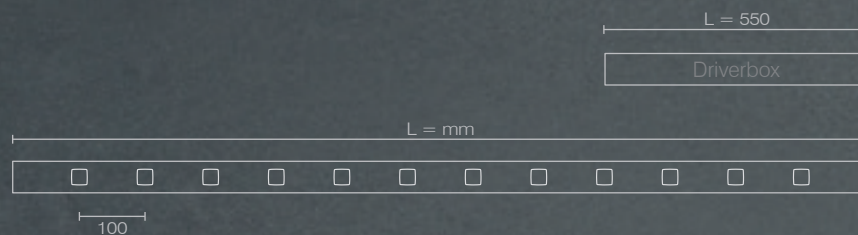

32 P+

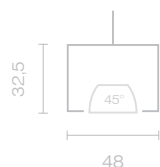

**45°
direct**

K	L=mm	#DOT	W	lm	CODE¹
3000	1.010	9	12	1.800	6532Z0232
	1.310	12	16	2.400	6532Z0332
	1.610	15	20	3.000	6532Z0432
	1.910	18	24	3.600	6532Z0532
4000	1.010	9	12	1.935	6532Z0242
	1.310	12	16	2.580	6532Z0342
	1.610	15	20	3.225	6532Z0442
	1.910	18	24	3.870	6532Z0542
tuneable white 2700 / 5700	1.310	12	8 / 8	1.020 / 1.140	6532Z03T2
	1.610	15	10 / 10	1.275 / 1.425	6532Z04T2
	1.910	18	12 / 12	1.530 / 1.710	6532Z05T2

**45°
direct / indirect**

K	L=mm	#DOT	W	lm direct	lm indirect	CODE¹
3000	1.010	9	20	1.800	1.200	6532Z1232
	1.310	12	29	2.400	1.200	6532Z1332
	1.610	15	37	3.000	1.800	6532Z1432
	1.910	18	45	3.600	1.800	6532Z1532
4000	1.010	9	20	1.935	1.290	6532Z1242
	1.310	12	29	2.580	1.290	6532Z1342
	1.610	15	37	3.225	1.935	6532Z1442
	1.910	18	45	3.870	1.935	6532Z1542
tuneable white 2700 / 5700	1.010	9	20	785 / 855	1.290	6532Z12T2
	1.310	12	29	1.020 / 1.140	1.290	6532Z13T2
	1.610	15	37	1.275 / 1.425	1.935	6532Z14T2
	1.910	18	45	1.530 / 1.710	1.935	6532Z15T2

Für Lichtfarbe 2700 K bitte die vorletzte Stelle der Artikelnummer durch 2 ersetzen
For CCT 2700 K please replace the penultimate digit of the item number by 2

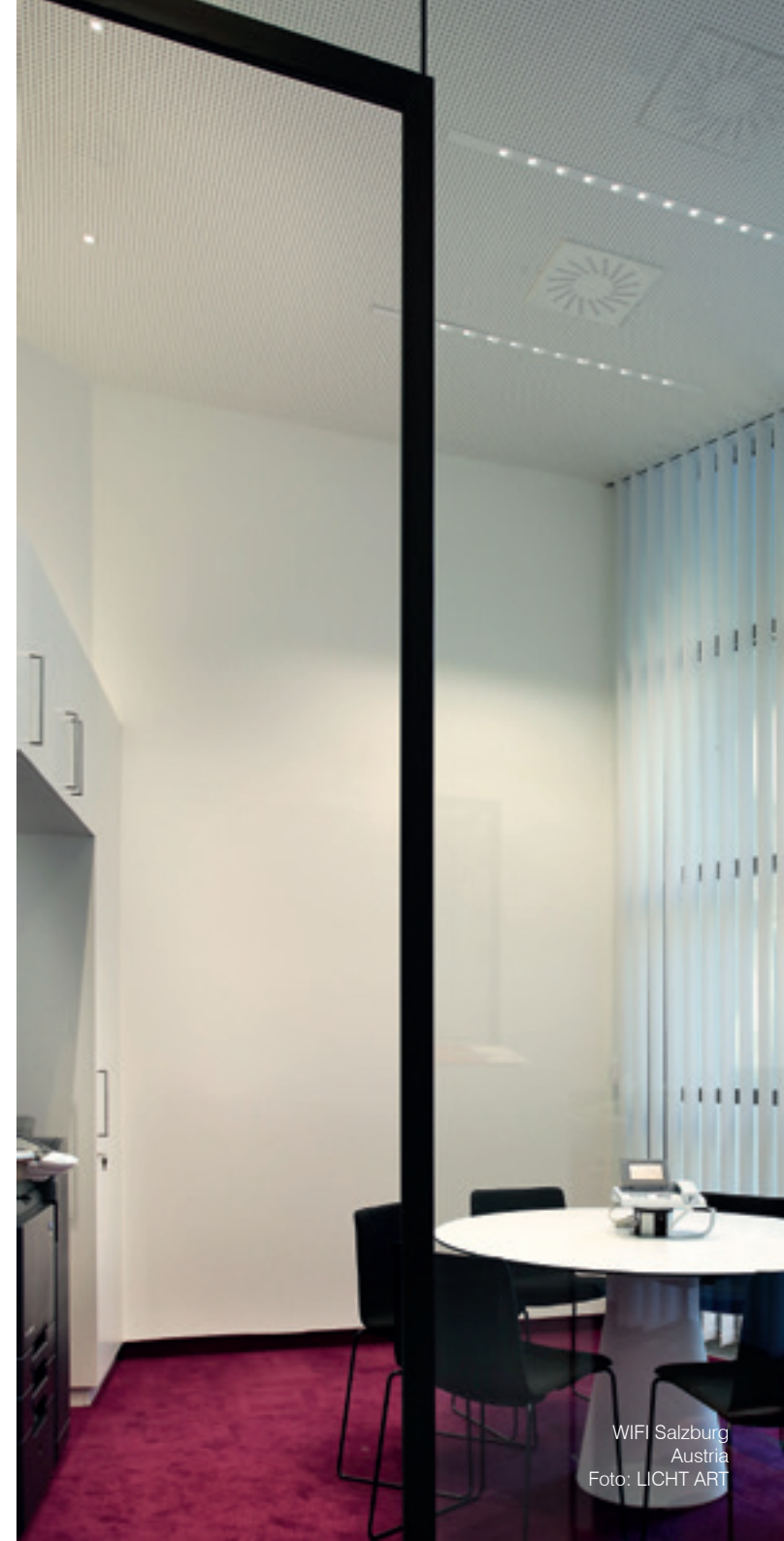

Einbauleuchten

Recessed luminaire

Schlichtes Design, das strahlt

Die drop line Einbauleuchten überzeugen durch ihre schlichte Eleganz. Das klare Design lässt unsere Leuchten Teil des Raumes werden und sind daher die ideale Lösung für jedes Lichtkonzept. Mit zurückhaltender Oberfläche überzeugen unsere drop line Einbauleuchten durch ihr blendfreies Licht und Design.

Die nachstehenden drop lines sind Leuchten mit vordefinierten Längen der unterschiedlichen Profiltypen inkl. allem notwendigen Zubehör. Wie gewohnt, sind alle Profile in Aluminium eloxiert, weiß oder schwarz erhältlich. Andere Farben der RAL oder NCS-Farbpalette sind selbstverständlich ebenfalls möglich.

Simple elegance

The drop line recessed luminaires impress with their simple elegance. The clear design allows our lights to be an integral part of the room and is therefore the ideal solution for every light concept. With unobtrusive surface, our drop line recessed luminaires impress with their glare-free light and design.

The following drop lines are luminaires with fixed lengths of different profile types including all the necessary accessories. As is usual, all the profiles are available in anodized aluminium, white or black. Various colours out of the RAL and NCS colour range on request.

Einbau
Recessed
frameless

65 E

- drop Reflektoren 45° bzw. 35°
Aluminium bedampft laut angegebener Stückzahl (#DOT), Echtgold beschichtete Reflektoren 45° auf Anfrage möglich
drop reflectors 45° or 35° aluminium metalised according to the specified number of units (#DOT)
gold coated reflectors 45° on request
- Aluminiumprofil natureloxiert in angeführter Länge
Standard Oberflächen siehe Seite 60
Anodised aluminium profile in the specified length
for colour options refer to page 60
- LED Platine – Mid-Power-LEDs
Lichtfarbe nach Wahl
LED PCB – Mid-Power-LEDs
please specify CCT when ordering
- Enddeckel
Einbaumontagebügel für Deckenstärke 12,5 mm
End caps
Mounting bracket for 12,5 mm ceiling thickness
- Entsprechender Konverter im Leuchtenprofil integriert
Matching driver integrated into profile
- [†] DALI dimmbar = code + D
tuneable white DALI dimmbar
[†] DALI dimmable = code + D
tuneable white DALI dimmable
- Einbautiefe = min. 80 mm
Installation depth = min. 80 mm
- Optionales Zubehör:
Gipskarton Einbaukanal siehe Seite 58
Optional accessories:
recessed channel for plaster board
refer to page 58

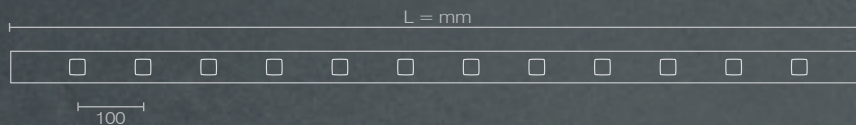

65 E

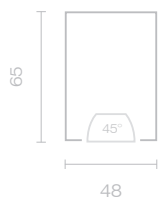

45°	K	L=mm	DA=mm	#DOT	W	lm	CODE ¹
3000		1.010	50 x 1.012	9	12	1.800	6565E0232
		1.310	50 x 1.312	12	16	2.400	6565E0332
		1.610	50 x 1.612	15	20	3.000	6565E0432
		1.910	50 x 1.912	18	24	3.600	6565E0532
4000		1.010	50 x 1.012	9	12	1.935	6565E0242
		1.310	50 x 1.312	12	16	2.580	6565E0342
		1.610	50 x 1.612	15	20	3.225	6565E0442
		1.910	50 x 1.912	18	24	3.870	6565E0542
tuneable white 2700 / 5700		1.310	50 x 1.312	12	8 / 8	1.020 / 1.140	6565E03T2
		1.610	50 x 1.612	15	10 / 10	1.275 / 1.425	6565E04T2
		1.910	50 x 1.912	18	12 / 12	1.530 / 1.710	6565E05T2

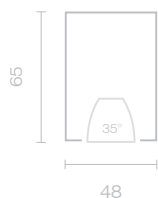

35°	K	L=mm	DA=mm	#DOT	W	lm	CODE ¹
3000		1.010	50 x 1.012	9	12	1.800	6565E0231
		1.310	50 x 1.312	12	16	2.400	6565E0331
		1.610	50 x 1.612	15	20	3.000	6565E0431
		1.910	50 x 1.912	18	24	3.600	6565E0531
4000		1.010	50 x 1.012	9	12	1.935	6565E0241
		1.310	50 x 1.312	12	16	2.580	6565E0341
		1.610	50 x 1.612	15	20	3.225	6565E0441
		1.910	50 x 1.912	18	24	3.870	6565E0541
tuneable white 2700 / 5700		1.310	50 x 1.312	12	8 / 8	1.020 / 1.140	6565E03T1
		1.610	50 x 1.612	15	10 / 10	1.275 / 1.425	6565E04T1
		1.910	50 x 1.912	18	12 / 12	1.530 / 1.710	6565E05T1

Für Lichtfarbe 2700 K bitte die vorletzte Stelle der Artikelnummer durch 2 ersetzen
For CCT 2700 K please replace the penultimate digit of the item number by 2

Einbau
Recessed
with frame

66 E

- drop Reflektoren 45° bzw. 35°
Aluminium bedampft laut angegebener Stückzahl (#DOT)
Echtgold beschichtete Reflektoren 45° auf Anfrage möglich
drop reflectors 45° or 35° aluminium metalised according to the specified number of units (#DOT)
gold coated reflectors 45° on request
- Aluminiumprofil natureloxiiert mit dezentem Rand in angeführter Länge
Standard Oberflächen siehe Seite 60
Anodised aluminium profile with small frame in the specified length
for colour options refer to page 60
- LED Platine – Mid-Power-LEDs
Lichtfarbe nach Wahl
LED PCB – Mid-Power-LEDs
please specify CCT when ordering
- Enddeckel
Einbaumontagebügel für Deckenstärke 12,5 mm
End caps
Mounting bracket for 12,5 mm ceiling thickness
- Entsprechender Konverter im Leuchtenprofil integriert
Matching driver integrated into profile
- ¹ DALI dimmbar = code + D
tuneable white DALI dimmbar
¹ DALI dimmable = code + D
tuneable white DALI dimmable
- Einbautiefe = min. 105 mm
Installation depth = min. 105 mm

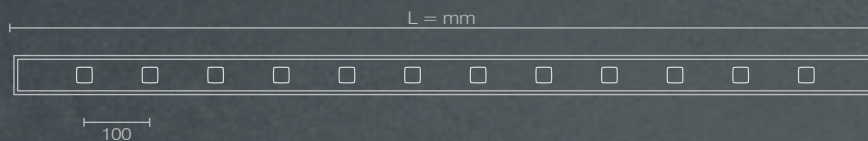

66 E

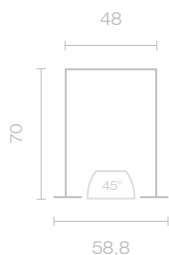

45°

K	L=mm	DA=mm	#DOT	W	lm	CODE ¹
3000	1.020	52 x 1.014	9	12	1.800	6566E0232
	1.320	52 x 1.314	12	16	2.400	6566E0332
	1.620	52 x 1.614	15	20	3.000	6566E0432
	1.920	52 x 1.914	18	24	3.600	6566E0532
4000	1.020	52 x 1.014	9	12	1.935	6566E0242
	1.320	52 x 1.314	12	16	2.580	6566E0342
	1.620	52 x 1.614	15	20	3.225	6566E0442
	1.920	52 x 1.914	18	24	3.870	6566E0542
tuneable white 2700 / 5700	1.320	52 x 1.314	12	8 / 8	1.020 / 1.140	6566E03T2
	1.620	52 x 1.614	15	10 / 10	1.275 / 1.425	6566E04T2
	1.920	52 x 1.914	18	12 / 12	1.530 / 1.710	6566E05T2

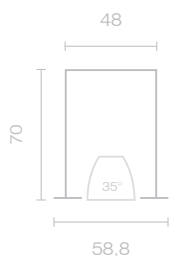

35°

K	L=mm	DA=mm	#DOT	W	lm	CODE ¹
3000	1.020	52 x 1.014	9	12	1.800	6566E0231
	1.320	52 x 1.314	12	16	2.400	6566E0331
	1.620	52 x 1.614	15	20	3.000	6566E0431
	1.920	52 x 1.914	18	24	3.600	6566E0531
4000	1.020	52 x 1.014	9	12	1.935	6566E0241
	1.320	52 x 1.314	12	16	2.580	6566E0341
	1.620	52 x 1.614	15	20	3.225	6566E0441
	1.920	52 x 1.914	18	24	3.870	6566E0541
tuneable white 2700 / 5700	1.320	52 x 1.314	12	8 / 8	1.020 / 1.140	6566E03T1
	1.620	52 x 1.614	15	10 / 10	1.275 / 1.425	6566E04T1
	1.920	52 x 1.914	18	12 / 12	1.530 / 1.710	6566E05T1

Für Lichtfarbe 2700 K bitte die vorletzte Stelle der Artikelnummer durch 2 ersetzen
For CCT 2700 K please replace the penultimate digit of the item number by 2

Einbau
Recessed
frameless

32 E

- drop Reflektoren 45° Aluminium bedampft laut angegebener Stückzahl (#DOT)
Echtgold beschichtete Reflektoren 45° auf Anfrage möglich
drop reflectors 45° aluminium metalised according to the specified number of units (#DOT)
gold coated reflectors 45° on request
- Aluminiumprofil natureloxiert in angeführter Länge
Standard Oberflächen siehe Seite 60
Anodised aluminium profile in the specified length
for colour options refer to page 60
- LED Platine – Mid-Power-LEDs
Lichtfarbe nach Wahl
LED PCB – Mid-Power-LEDs
please specify CCT when ordering
- Enddeckel
Einbaumontagebügel für Deckenstärke 12,5 mm
End caps
Mounting bracket for 12,5 mm ceiling thickness
- Entsprechender Konverter als Deckeneinwurfgerät
drop groups:
im Blindteil der Leuchte integriert
Matching driver
as a ceiling void unit
drop groups:
integrated into profil behind blind part
- 1 DALI dimmbar = code + D
tuneable white DALI dimmbar
1 DALI dimmable = code + D
tuneable white DALI dimmable
- Einbautiefe = min. 65 mm
Installation depth = min. 65 mm
- Optionales Zubehör:
Gipskarton Einbaukanal siehe Seite 58
Optional accessories:
recessed channel for plaster board
refer to page 58

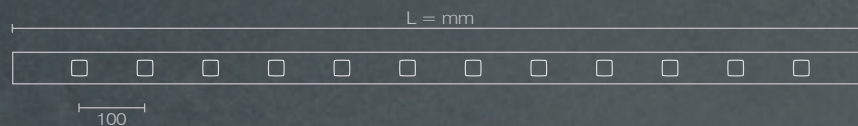

32 E

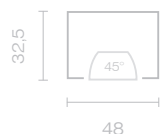

45°	K	L=mm	DA=mm	#DOT	W	lm	CODE ¹
3000		710	50 x 712	6	8	1.200	6532E0132
		1.010	50 x 1.012	9	12	1.800	6532E0232
		1.310	50 x 1.312	12	16	2.400	6532E0332
		1.610	50 x 1.612	15	20	3.000	6532E0432
		1.910	50 x 1.912	18	24	3.600	6532E0532
4000		710	50 x 712	6	8	1.290	6532E0142
		1.010	50 x 1.012	9	12	1.935	6532E0242
		1.310	50 x 1.312	12	16	2.580	6532E0342
		1.610	50 x 1.612	15	20	3.225	6532E0442
		1.910	50 x 1.912	18	24	3.870	6532E0542
tuneable white 2700 / 5700		1.010	50 x 1.012	9	12	765 / 855	6532E02T2
		1.310	50 x 1.312	12	16	1.020 / 1.140	6532E03T2
		1.610	50 x 1.612	15	20	1.275 / 1.425	6532E04T2
		1.910	50 x 1.912	18	24	1.530 / 1.710	6532E05T2

drop group

45°	K	L=mm	DA=mm	#DOT	W	lm	CODE ¹
3000		1.350	50 x 1.352	2 x 4	11	1.600	6532E2132
		1.900	50 x 1.902	3 x 3	12	1.800	6532E2232
		2.200	50 x 2.202	3 x 4	16	2.400	6532E2332
4000		1.350	50 x 1.352	2 x 4	11	1.720	6532E2142
		1.900	50 x 1.902	3 x 3	12	1.935	6532E2242
		2.200	50 x 2.202	3 x 4	16	2.580	6532E2342



Für Lichtfarbe 2700 K bitte die vorletzte Stelle der Artikelnummer durch 2 ersetzen
 For CCT 2700 K please replace the penultimate digit of the item number by 2

Einbau
Recessed
with frame

33 E

- drop Reflektoren 45° Aluminium bedampft laut angegebener Stückzahl (#DOT)
Echtgold beschichtete Reflektoren 45° auf Anfrage möglich
drop reflectors 45° aluminium metalised according to the specified number of units (#DOT)
gold coated reflectors 45° on request
- Aluminiumprofil natureloxiiert mit dezentem Rand in angeführter Länge
Standard Oberflächen siehe Seite 60
Anodised aluminium profile with samll frame in the specified length
for colour options refer to page 60
- LED Platine – Mid-Power-LEDs
Lichtfarbe nach Wahl
LED PCB – Mid-Power-LEDs
please specify CCT when ordering
- Enddeckel
Einbaumontagebügel
für Deckenstärke 12,5 mm
End caps
Mounting bracket
for ceiling thickness 12,5 mm
- Entsprechender Konverter als Deckeneinwurfgerät
Matching driver
as a ceiling void unit
- ¹ DALI dimmbar = code + D
tuneable white DALI dimmbar
¹ DALI dimmable = code + D
tuneable white DALI dimmable I
- Einbautiefe = min. 65 mm
Installation depth = min. 65 mm

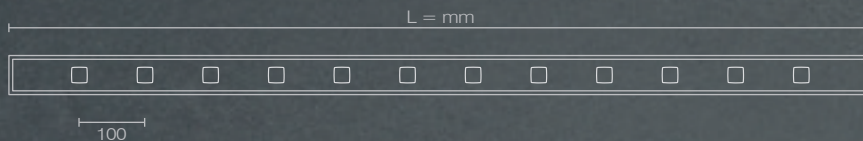
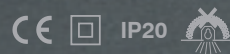

33 E

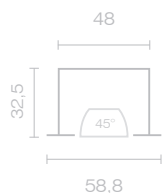

45°

K	L=mm	DA=mm	#DOT	W	lm	CODE ¹
3000	720	52 x 714	6	8	1.200	6533E0132
	1.020	52 x 1.014	9	12	1.800	6533E0232
	1.320	52 x 1.314	12	16	2.400	6533E0332
	1.620	52 x 1.614	15	20	3.000	6533E0432
	1.920	52 x 1.914	18	24	3.600	6533E0532
4000	720	52 x 714	6	8	1.290	6533E0142
	1.020	52 x 1.014	9	12	1.935	6533E0242
	1.320	52 x 1.314	12	16	2.580	6533E0342
	1.620	52 x 1.614	15	20	3.225	6533E0442
	1.920	52 x 1.914	18	24	3.870	6533E0542
tuneable white 2700 / 5700	1.020	52 x 1.014	9	12	765 / 855	6533E02T2
	1.320	52 x 1.314	12	16	1.020 / 1.140	6533E03T2
	1.620	52 x 1.614	15	20	1.275 / 1.425	6533E04T2
	1.920	52 x 1.914	18	24	1.530 / 1.710	6533E05T2

Für Lichtfarbe 2700 K bitte die vorletzte Stelle der Artikelnummer durch 2 ersetzen
For CCT 2700 K please replace the penultimate digit of the item number by 2



Aufbauleuchten

Surface luminaire

Elegantes Design

drop line Aufbauleuchten sind sowohl durch ihr modernes und zeitloses Design, als auch durch ihre niedrige Bauform ein Blickfang auf jeder Decke. Setzen Sie Akzente durch perfekte Lichtgebung und elegantes Design.

Die nachstehenden drop lines sind Leuchten mit vordefinierten Längen der unterschiedlichen Profiltypen inkl. allem notwendigen Zubehör. Wie gewohnt, sind alle Profile in Aluminium eloxiert, weiß oder schwarz erhältlich. Andere Farben der RAL oder NCS-Farbpalette sind selbstverständlich ebenfalls möglich.

Elegant design

drop line surface luminaires are an eye catcher on every ceiling due to their modern and time-less design as well as their low structural shape. Highlight features through perfect light output and elegant design.

The following drop lines are lights with fixed lengths of different profile types including all the necessary accessories. As usual, all the profiles are available in anodized aluminium, white or black. Various colours out of the RAL and NCS colour range on request.

65 A

- drop Reflektoren 45° bzw. 35°
Aluminium bedampft laut angegebener Stückzahl (#DOT)
Echtgold beschichtete Reflektoren 45° auf Anfrage möglich
drop reflectors 45° or 35° aluminium metalised according to the specified number of units (#DOT)
gold coated reflectors 45° on request
- Aluminiumprofil natureloxiert in angeführter Länge
Standard Oberflächen siehe Seite 60
Anodised aluminium profile in the specified length
for colour options refer to page 60
- LED Platine – Mid-Power-LEDs
Lichtfarbe nach Wahl
LED PCB – Mid-Power-LEDs
please specify CCT when ordering
- Enddeckel
End caps
- Entsprechender Konverter im Leuchtenprofil integriert
Matching driver integrated into profil
- ¹ DALI dimmbar = code + D
tuneable white DALI dimmbar
¹ DALI dimmable = code + D
tuneable white DALI dimmable

CE  IP20

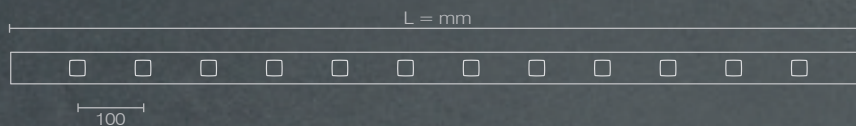

65 A

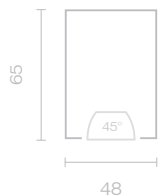

45°	K	L=mm	#DOT	W	lm	CODE ¹
3000		1.010	9	12	1.800	6565A0232
		1.310	12	16	2.400	6565A0332
		1.610	15	20	3.000	6565A0432
		1.910	18	24	3.600	6565A0532
4000		1.010	9	12	1.935	6565A0242
		1.310	12	16	2.580	6565A0342
		1.610	15	20	3.225	6565A0442
		1.910	18	24	3.870	6565A0542
tuneable white 2700 / 5700		1.310	12	8 / 8	1.020 / 1.140	6565A03T2
		1.610	15	10 / 10	1.275 / 1.425	6565A04T2
		1.910	18	12 / 12	1.530 / 1.710	6565A05T2

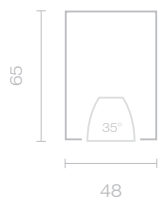

35°	K	L=mm	#DOT	W	lm	CODE ¹
3000		1.010	9	12	1.800	6565A0231
		1.310	12	16	2.400	6565A0331
		1.610	15	20	3.000	6565A0431
		1.910	18	24	3.600	6565A0531
4000		1.010	9	12	1.935	6565A0241
		1.310	12	16	2.580	6565A0341
		1.610	15	20	3.225	6565A0441
		1.910	18	24	3.870	6565A0541
tuneable white 2700 / 5700		1.310	12	8 / 8	1.020 / 1.140	6565A03T1
		1.610	15	10 / 10	1.275 / 1.425	6565A04T1
		1.910	18	12 / 12	1.530 / 1.710	6565A05T1

Für Lichtfarbe 2700 K bitte die vorletzte Stelle der Artikelnummer durch 2 ersetzen
 For CCT 2700 K please replace the penultimate digit of the item number by 2

32 A

- drop Reflektoren 45° Aluminium bedampft laut angegebener Stückzahl (#DOT)
Echtgold beschichtete Reflektoren 45° auf Anfrage möglich
drop reflectors 45° aluminium metalised according to the specified number of units (#DOT)
gold coated reflectors 45° on request
- Aluminiumprofil natureloxiert in angeführter Länge
Standard Oberflächen siehe Seite 60
Anodised aluminium profile in the specified length
for colour options refer to page 60
- LED Platine – Mid-Power-LEDs
Lichtfarbe nach Wahl
LED PCB – Mid-Power-LEDs
please specify CCT when ordering
- Enddeckel
End caps
- Entsprechender Konverter im Blindteil der Leuchte integriert
Matching driver integrated into profile behind blind part
- ¹ DALI dimmbar = code + D
¹ DALI dimmable = code + D

CE IP20

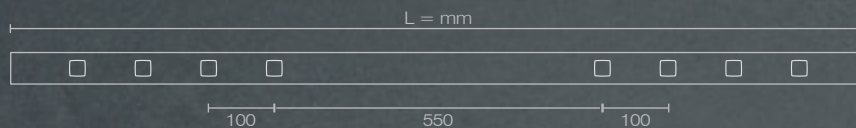

32 A

drop group

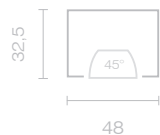

45°

K	L=mm	#DOT	W	lm	CODE¹
3000	1.350	2 x 4	11	1.600	6532A2132
	1.900	3 x 3	12	1.800	6532A2232
	2.200	3 x 4	16	2.400	6532A2332
4000	1.350	2 x 4	11	1.720	6532A2142
	1.900	3 x 3	12	1.935	6532A2242
	2.200	3 x 4	16	2.580	6532A2342



Für Lichtfarbe 2700 K bitte die vorletzte Stelle der Artikelnummer durch 2 ersetzen
For CCT 2700 K please replace the penultimate digit of the item number by 2

drop in



drop
custom made

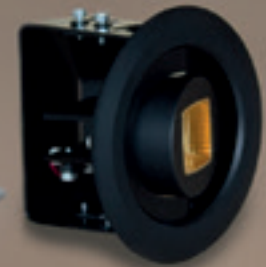

tiny drop

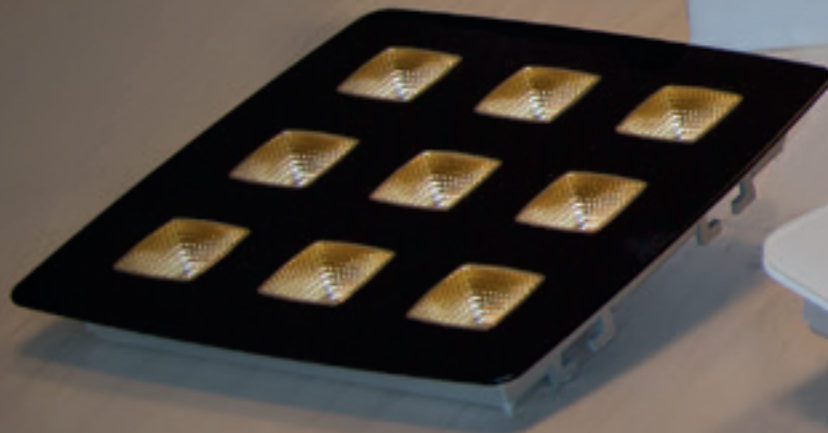

drop field 3x3
black / gold



drop field 3x3
white / silver IP44

tiny drop ^Q



tiny up
black / gold



drop field 2x2
white / gold



drop field 2x2 ^Q
white / silver

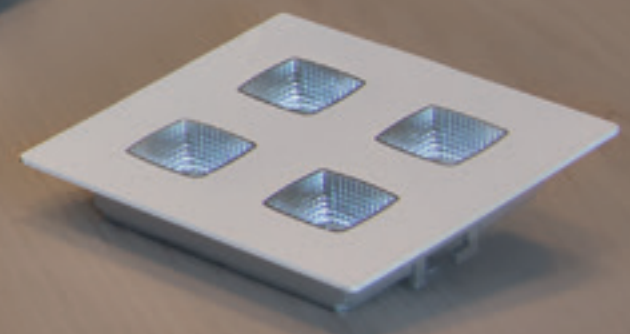



Lichtfelder Lightfields

Design pur

Durch das flache und puristische Design der drop fields ist der Fokus hauptsächlich auf die Reflektoren gerichtet. Ihr einzigartiges Design dient nicht nur der idealen Lichtverteilung und Blendungsbegrenzung, sondern ist auch ein formschöner Blickfang auf jeder Decke.

Alle unsere drop fields sind feinstruktur pulverbeschichtet, weiß, schwarz oder grau erhältlich. Andere Farben der RAL oder NCS-Farbpalette sind selbstverständlich ebenfalls möglich.

Pure Design

Thanks to the flat and puristic design of the drop fields the focus is predominantly on the reflectors. Its unique design does not only enable ideal light distribution and glare limitation, but is also an elegant eye-catcher on every ceiling.

All our drop field are micro textured powder coated and available in white, black or grey colour. Various colours out of the RAL and NCS colour range on request.

Einbau
Recessed

2x2 | Q



- drop Reflektoren 45° Aluminium bedampft (35° Reflektoren auf Anfrage)
4 Lichtpunkte (#DOT) pro Leuchte
Echtgold beschichtete Reflektoren 45° verfügbar
drop reflectors 45° aluminium metalised (35° reflectors on request)
4 light points (#DOT) per luminaire
gold coated reflectors 45° available
- Frontblende feinstruktur pulverbeschichtet
Micro textured powder coated front cover
- LED Platine – Mid-Power-LEDs
Lichtfarbe nach Wahl
LED PCB – Mid-Power-LEDs
please specify CCT when ordering
- Konverter bitte separat bestellen, Einbautiefe von Konvertertyp abhängig, siehe Seite 56-57
Please order driver separately, installation depth depending on type of driver, refer to page 56-57
- tuneable white DALI dimmbar
tuneable white DALI dimmable
- Deckenausschnitt = 80 x 80 mm
Ceiling cut out = 80 x 80 mm
- IP44 - mit Schutzglas
IP44 - with protection glass

40

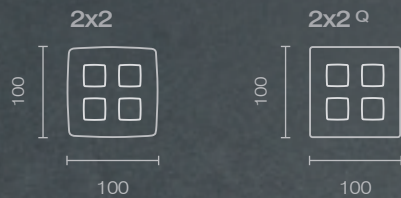

2x2 | Q

45°	2x2	W	K	lm	CODE		
					white	black	grey
IP20	9		2700	1.050	657222-5	657222-6	657222
			3000	1.150	657232-5	657232-6	657232
			4000	1.250	657242-5	657242-6	657242
			tuneable white 2700 / 5700	530 / 620	6572T2-5	6572T2-6	6572T2
IP44	9		2700	1.050	657P222-5		
			3000	1.150	657P232-5		
			4000	1.250	657P242-5		
			tuneable white 2700 / 5700	530 / 620	657P2T2-5		
45°	2x2 Q	W	K	lm	CODE		
					white	black	grey
IP20	9		2700	1.050	657222-Q-5	657222-Q-6	657222-Q
			3000	1.150	657232-Q-5	657232-Q-6	657232-Q
			4000	1.250	657242-Q-5	657242-Q-6	657242-Q
			tuneable white 2700 / 5700	530 / 620	6572T2-Q-5	6572T2-Q-6	6572T2-Q
IP44	9		2700	1.050	657P222-Q-5		
			3000	1.150	657P232-Q-5		
			4000	1.250	657P242-Q-5		
			tuneable white 2700 / 5700	530 / 620	657P2T2-Q-5		
45°	black-gold	W	K	lm	CODE		
					black-gold		
IP20	9		2700	1.050	657224-6		
			3000	1.150	657234-6		
45°	black-gold Q	W	K	lm	CODE		
					black-gold		
IP20	9		2700	1.050	657224-Q-6		
			3000	1.150	657234-Q-6		



Einbau
Recessed

3x3 | Q

- drop Reflektoren 45° Aluminium bedampft (35° Reflektoren auf Anfrage)
9 Lichtpunkte (#DOT) pro Leuchte
Echtgold beschichtete Reflektoren 45° verfügbar
drop reflectors 45° aluminium metalised (35° reflectors on request)
9 light points (#DOT) per luminaire
gold coated reflectors 45° available
- Frontblende feinstruktur pulverbeschichtet
Micro textured powder coated front cover
- LED Platine – Mid-Power-LEDs
Lichtfarbe nach Wahl
LED PCB – Mid-Power-LEDs
please specify CCT when ordering
- Konverter bitte separat bestellen, Einbautiefe von Konvertertyp abhängig, siehe Seite 56-57
Please order driver separately, installation depth depending on type of driver, refer to page 56-57
- tuneable white DALI dimmbar
tuneable white DALI dimmable
- Deckenausschnitt = 125 x 125 mm
Ceiling cut out = 125 x 125 mm
- IP44 - mit Schutzglas
IP44 - with protection glass

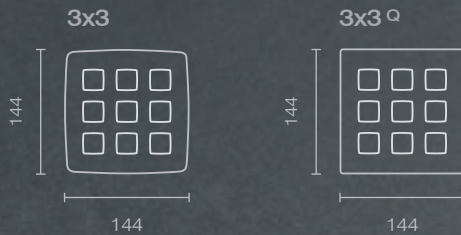

3x3 | Q

45°	3x3	W	K	lm	CODE	black	grey
					white		
IP20	18	2700	2700	2.300	657322-5	657322-6	657322
			3000	2.500	657332-5	657332-6	657332
			4000	2.700	657342-5	657342-6	657342
			tuneable white 2700 / 5700	1.170 / 1.350	6573T2-5	6573T2-6	6573T2
IP44	18	2700	2700	2.330	657P322-5		
			3000	2.500	657P332-5		
			4000	2.700	657P342-5		
			tuneable white 2700 / 5700	1.170 / 1.350	657P3T2-5		
45°	3x3 Q	W	K	lm	CODE	black	grey
					white		
IP20	18	2700	2700	2.300	657322-Q-5	657322-Q-6	657322-Q
			3000	2.500	657332-Q-5	657332-Q-6	657332-Q
			4000	2.700	657342-Q-5	657342-Q-6	657342-Q
			tuneable white 2700 / 5700	1.170 / 1.350	6573T2-Q-5	6573T2-Q-6	6573T2-Q
IP44	18	2700	2700	2.330	657P322-Q-5		
			3000	2.500	657P332-Q-5		
			4000	2.700	657P342-Q-5		
			tuneable white 2700 / 5700	1.170 / 1.350	657P3T2-Q-5		
45°	black-gold	W	K	lm	CODE	black-gold	
					black-gold		
IP20	18	2700	2700	2.300	657324-6		
			3000	2.500	657334-6		
45°	black-gold Q	W	K	lm	CODE	black-gold	
					black-gold		
IP20	18	2700	2700	2.300	657324-Q-6		
			3000	2.500	657334-Q-6		

4x4 | Q

45°	K	W	lm	CODE 4x4			CODE 4x4 ^Q		
				grey	white	black	grey	white	black
2700		23	3.200	657422	-5	-6	657422-Q	-5	-6
		32	4.250	657422-H	-5	-6	657422-QH	-5	-6
3000		23	3.400	657432	-5	-6	657432-Q	-5	-6
		32	4.650	657432-H	-5	-6	657432-QH	-5	-6
4000		23	3.700	657442	-5	-6	657442-Q	-5	-6
		32	5.000	657442-H	-5	-6	657442-QH	-5	-6
tuneable white 2700 / 5700		23	1.600 / 1.850	6574T2	-5	-6	6574T2-Q	-5	-6
		32	2.125 / 2.475	6574T2-H	-5	-6	6574T2-QH	-5	-6

35°	K	W	lm	CODE 4x4			CODE 4x4 ^Q		
				grey	white	black	grey	white	black
2700		23	3.200	657421	-5	-6	657421-Q	-5	-6
		32	4.250	657421-H	-5	-6	657421-QH	-5	-6
3000		23	3.400	657431	-5	-6	657431-Q	-5	-6
		32	4.650	657431-H	-5	-6	657431-QH	-5	-6
4000		23	3.700	657441	-5	-6	657441-Q	-5	-6
		32	5.000	657441-H	-5	-6	657441-QH	-5	-6
tuneable white 2700 / 5700		23	1.600 / 1.850	6574T1	-5	-6	6574T1-Q	-5	-6
		32	2.125 / 2.475	6574T1-H	-5	-6	6574T1-QH	-5	-6



Einbau
Recessed

4x4 | Q

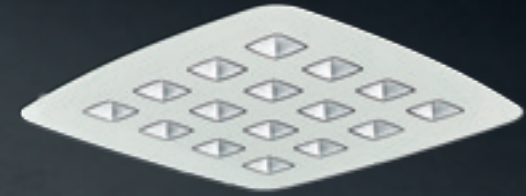

- drop Reflektoren 45° bzw. 35°
Aluminium bedampft
16 Lichtpunkte (#DOT) pro Leuchte
Echtgold beschichtete Reflektoren 45°
verfügbar
drop reflectors 45° or 35° aluminium
metallisation
16 light points (#DOT) per luminaire
gold coated reflectors 45° available
- Frontblende feinstruktur pulverbeschichtet
Micro textured powder coated front cover
- LED Platine – Mid-Power-LEDs
Lichtfarbe nach Wahl
LED PCB – Mid-Power-LEDs
please specify CCT when ordering
- Konverter bitte separat bestellen,
Einbautiefe von Konvertertyp abhängig,
siehe Seite 56-57
Please order driver separately,
instalation depth depending on type of
driver, refer to page 56-57
- tuneable white DALI dimmbar
tuneable white DALI dimmable
- Deckenausschnitt = 165 x 165 mm
Ceiling cut out = 165 x 165 mm

45

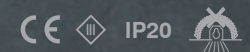
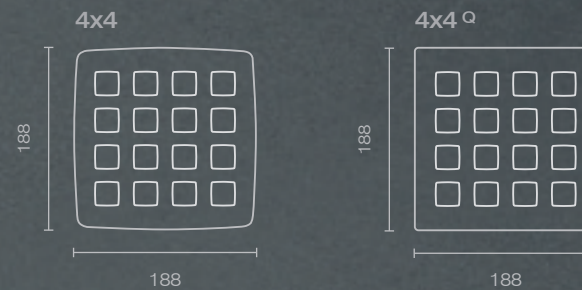

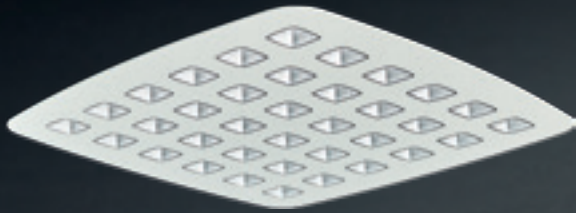

Einbau
Recessed

6x6 | Q

- drop Reflektoren 45° bzw. 35°
Aluminium bedampft
36 Lichtpunkte (#DOT) pro Leuchte
Echtgold beschichtete Reflektoren 45°
verfügbar
drop reflectors 45° or 35° aluminium
metallisation
36 light points (#DOT) per luminaire
gold coated reflectors 45° available
- Konverter bitte separat bestellen,
Einbautiefe von Konvertertyp abhängig,
siehe Seite 56-57
Please order driver separately,
instalation depth depending on type of
driver, refer to page 56-57
- Frontblende feinstruktur pulverbeschichtet
Micro textured powder coated front cover
- tuneable white DALI dimmbar
tuneable white DALI dimmable
- LED Platine – Mid-Power-LEDs
Lichtfarbe nach Wahl
LED PCB – Mid-Power-LEDs
please specify CCT when ordering
- Deckenausschnitt = 250 x 250 mm
Ceiling cut out = 250 x 250 mm

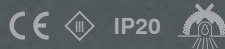
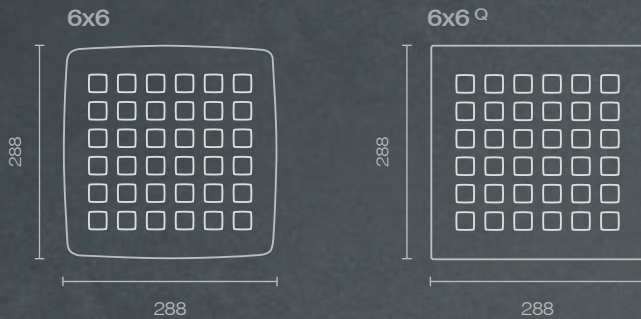

6x6 | Q

45°	K	W	lm	CODE 6x6			CODE 6x6 ^Q		
				grey	white	black	grey	white	black
2700		48	6.700	657622	-5	-6	657622-Q	-5	-6
		62	8.300	657622-H	-5	-6	657622-QH	-5	-6
3000		48	7.100	657632	-5	-6	657632-Q	-5	-6
		62	8.700	657632-H	-5	-6	657632-QH	-5	-6
4000		48	7.500	657642	-5	-6	657642-Q	-5	-6
		62	9.400	657642-H	-5	-6	657642-QH	-5	-6
tuneable white 2700 / 5700		48	3.370 / 3.900	6576T2	-5	-6	6576T2-Q	-5	-6
		62	4.150 / 4.810	6576T2-H	-5	-6	6576T2-QH	-5	-6

35°	K	W	lm	CODE 6x6			CODE 6x6 ^Q		
				grey	white	black	grey	white	black
2700		48	6.700	657621	-5	-6	657621-Q	-5	-6
		62	8.300	657621-H	-5	-6	657621-QH	-5	-6
3000		48	7.100	657631	-5	-6	657631-Q	-5	-6
		62	8.700	657631-H	-5	-6	657631-QH	-5	-6
4000		48	7.500	657641	-5	-6	657641-Q	-5	-6
		62	9.400	657641-H	-5	-6	657641-QH	-5	-6
tuneable white 2700 / 5700		48	3.370 / 3.900	6576T1	-5	-6	6576T1-Q	-5	-6
		62	4.150 / 4.810	6576T1-H	-5	-6	6576T1-QH	-5	-6



Restaurant Bad Waltersdorf
Austria
Foto: LICHT ART

Einzellichtpunkt Single light point

Design auf den Punkt gebracht

Unser tiny drop ist die kleinste Leuchte im drop Sortiment, darf deshalb aber keinesfalls unterschätzt werden. Punktuell kann man mit dieser modernen Leuchte in den verschiedensten Anwendungsbereichen Akzente setzen und so ein ganz spezielles Ambiente schaffen.

Unser tiny drop ist in den Oberflächen weiß, schwarz oder Aluminium eloxiert erhältlich. Andere Farben der RAL oder NCS-Farbpalette sind selbstverständlich ebenfalls möglich.

Design gets to the point

The tiny drop is the smallest luminaire in our product range, but that does not mean it can be underrated. With this modern luminaire new standards are be set for many applications in various areas and thus create a special ambience.

Our tiny drop can be delivered in white, black or aluminium anodized. Various colours out of the RAL and NCS colour range on request.

Einbau
Recessed



tiny drop

- drop Reflektor 45° Aluminium bedampft, Echtgold beschichtete Reflektoren 45° verfügbar
drop reflectors 45° aluminium metalised gold coated reflectors 45° available
- Frontblende aus Aluminium natur eloxiert, schwarz eloxiert oder weiß pulverbeschichtet, Front cover in anodized aluminium, black anodized or white powder coated
- LED COB Modul
Lichtfarbe nach Wahl
LED COB Module
please specify CCT when ordering
- Konverter bitte separat bestellen, Einbautiefe von Konvertertyp abhängig, siehe Seite 56-57
Please order driver separately, instalation depth depending on type of driver, refer to page 56-57
- Deckenausschnitt = \varnothing 48 mm
Ceiling cut out = \varnothing 48 mm
- IP44 - mit Schutzglas
IP44 - with protection glass

50

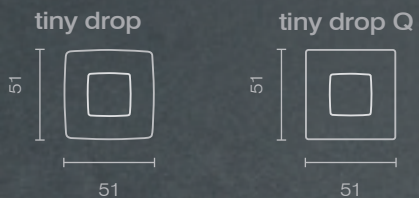

tiny drop

45°	tiny drop	W	K	lm	CODE		
					white	black	alu
IP20		10	2700	1.000	650022-5	650022-6	650022
			3000	1.050	650032-5	650032-6	650032
			4000	1.100	650042-5	650042-6	650042
IP44		10	2700	1.000	650122-5		
			3000	1.050	650132-5		
			4000	1.100	650142-5		

45°	tiny drop Q	W	K	lm	CODE		
					white	black	alu
IP20		10	2700	1.000	650022-Q-5	650022-Q-6	650022-Q
			3000	1.050	650032-Q-5	650032-Q-6	650032-Q
			4000	1.100	650042-Q-5	650042-Q-6	650042-Q
IP44		10	2700	1.000	650122-Q-5		
			3000	1.050	650132-Q-5		
			4000	1.100	650142-Q-5		

45°	black-gold	W	K	lm	CODE		
					black-gold		
IP20		10	2700	1.000	650024-6		
			3000	1.050	650034-6		

45°	black-gold Q	W	K	lm	CODE		
					black-gold		
IP20		10	2700	1.000	650024-Q-6		
			3000	1.050	650034-Q-6		

Aufbau
Surface

tiny up



- drop Reflektor 45° Aluminium bedampft, Echtgold beschichtete Reflektoren 45° verfügbar
drop reflectors 45° aluminium metalised gold coated reflectors 45° available
- Leuchtgehäuse aus Aluminium natur eloxiert, schwarz oder weiß pulverbeschichtet, Luminaire housing in anodized aluminium, black or white powder coated
- LED COB Modul
Lichtfarbe nach Wahl
LED COB Module
please specify CCT when ordering
- Konverter nicht dimmbar im Leuchtgehäuse integriert
Non dimmable driver integrated in the housing of the luminaire
- IP44 - mit Schutzglas
IP44 - with protection glass

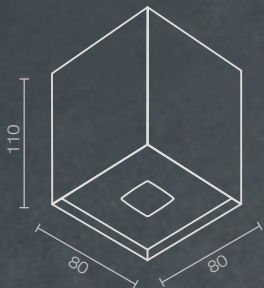

CE   IP20
IP44



tiny up

45°	tiny up	W	K	lm	CODE	black	alu
					white		
IP20		10	2700	1.000	650222-5	650222-6	650222
			3000	1.050	650232-5	650232-6	650232
			4000	1.100	650242-5	650242-6	650242
IP44		10	2700	1.000		650322-6	
			3000	1.050		650332-6	
			4000	1.100		650342-6	

45°	black-gold	W	K	lm	CODE
					black-gold
IP20		10	2700	1.000	650224-6
			3000	1.050	650234-6

Einbau
Recessed



drop in

- drop Reflektoren 45° bzw. 35°
Aluminium bedampft
Echtgold beschichtete Reflektoren 45° auf
Anfrage möglich
drop reflectors 45° or 35° aluminium
metalised
gold coated reflectors 45° on request
- Frontblende aus Aluminium natur eloxiert,
schwarz eloxiert, oder weiß pulverbeschichtet,
Front cover in anodized aluminium, black
anodized or white powder coated
- High Power LED Platine
Lichtfarbe nach Wahl
High power LED PCB
please specify CCT when ordering
- Konverter bitte separat bestellen,
Einbautiefe von Konvertertyp abhängig,
siehe Seite 56-57
Please order driver separately,
instalation depth depending on type of
driver, refer to page 56-57
- Deckenausschnitt = \varnothing 68 mm
Ceiling cut out = \varnothing 68 mm

54



80

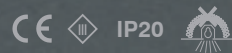

Umbrügger Alm
Austria
ING-B Ingenieurbüro GmbH

drop in

45°	drop in	W	K	lm	CODE	black	alu
					white		
IP20		12	2700	1.270	651022-5	651022-6	651022
			3000	1.360	651032-5	651032-6	651032
			4000	1.450	651042-5	651042-6	651042

35°	drop in	W	K	lm	CODE	black	alu
					white		
IP20		12	2700	1.270	651021-5	651021-6	651021
			3000	1.360	651031-5	651031-6	651031
			4000	1.450	651041-5	651041-6	651041

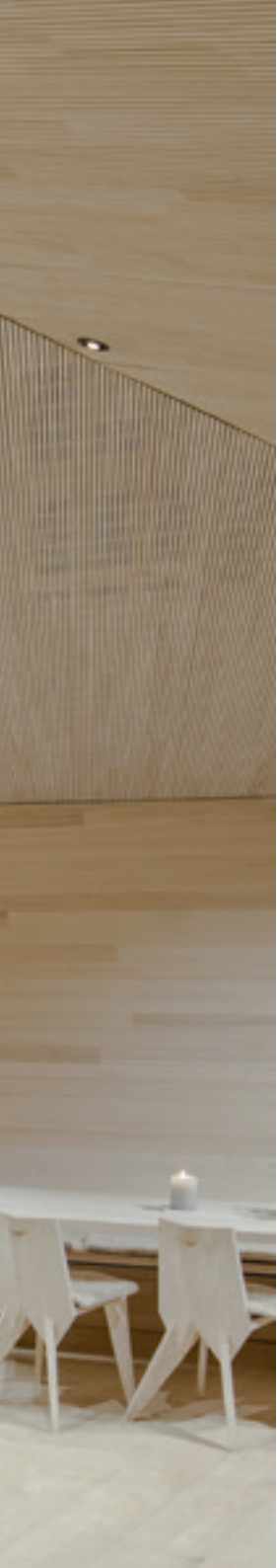

Driver

NON DIMMABLE

		size in mm l x b x h	#	power	output	ET in mm		CODE
drop field 2x2	9 W	65 x 39 x 20	1	9 W	700 mA	40		026150-700
		165 x 43 x 30	2-3	30 W	700 mA	85		026151-700
drop field 3x3	18 W	102 x 51 x 30	1	20 W	500 mA	50		026152-500
		225 x 47 x 28	1-2	40 W	500 mA	80		026145-500
drop field 4x4	23 W	225 x 47 x 28	1	40 W	500 mA	60		026145-500
		225 x 47 x 28	1	40 W	700 mA	60		026145-700
drop field 6x6	48 W	160 x 82 x 34	1	65 W	1.400 mA	80		026153-1400
		160 x 82 x 34	1	65 W	1.750 mA	80		026154-1750
tiny drop	10 W	115 x 34 x 19	1	15 W	350 mA	95		026155-350
		102 x 51 x 30	1-2	20 W	350 mA	80 ¹		026156-350
drop in	12 W	141 x 43 x 30	1-2	33 W	1.050 mA	100		026126-1050
		111 x 38 x 28	1	22 W	1.050 mA	100		026157-1050

DALI DIMMABLE

		size in mm l x b x h	#	power	output	ET in mm		CODE
drop field 2x2	9 W	120 x 53 x 30	1	15 W	700 mA	50		026163-700
		184 x 40 x 26	1-2	20 W	700 mA	85		026138-700
drop field 3x3	18 W	184 x 40 x 26	1	20 W	500 mA	60		026138-500
		225 x 47 x 28	1-2	40 W	500 mA	80		026139-500
drop field 4x4	23 W	225 x 47 x 28	1	40 W	500 mA	60		026139-500
		225 x 47 x 28	1	40 W	700 mA	60		026139-700
drop field 6x6	48 W	145 x 75 x 25	1	55 W	1.400 mA	80		026114-1400
		235 x 100 x 31	1	100 W	1.750 mA	80		026158-1750
tiny drop	10 W	180 x 32 x 32	1-2	17 W	350 mA	200		026159-350
		200 x 70 x 31	1	20 W	350 mA	80 ¹		026160-350
drop in	12 W	120 x 53 x 30	1	15 W	1.050 mA	100		026163-1050
		225 x 47 x 28	2-3	40 W	1.050 mA	190		026147-1050









= max. Anzahl Leuchten pro Konverter
max. number of luminaires per driver
ET= erforderliche Einbautiefe der Leuchte in mm
required installation depth in mm
¹ = Revisionsöffnung erforderlich
Revision opening required

Empfohlener Maximalabstand zwischen Leuchte und Konverter = 3.000 mm
Maximum recommended distance between luminaire and driver = 3.000 mm

Kabelbaum für steckbaren Anschluss von mehreren Leuchten auf Anfrage lieferbar.
Wiring harness for plug-in connection of several luminaire on request.

TUNEABLE WHITE

2 drivers →
1 luminaire

		size in mm l x b x h	#	power	output	ET in mm		CODE
drop field 2x2	9 W	120 x 53 x 30	2-3	15 W	700 mA	50		026163-700
		225 x 47 x 28	2-4	40 W	700 mA	100		026139-700
drop field 3x3	18 W	184 x 40 x 26	1-2	20 W	500 mA	60		026138-500
		225 x 47 x 28	2-4	40 W	500 mA	80		026139-500
drop field 4x4	23 W	225 x 47 x 28	1-2	40 W	500 mA	60		026139-500
		32 W	225 x 47 x 28	1-2	40 W	700 mA	60	
drop field 6x6	48 W	225 x 47 x 28	1	40 W	700 mA	80		026139-700
		62 W	145 x 75 x 25	1	55 W	900 mA	80	

Bei tuneable white wird für jede Lichtfarbe - 2700 K und 5700 K - je ein Konverter benötigt, beim drop field 2x2 müssen immer mindestens 2 Leuchten gemeinsam versorgt werden.

In case of tuneable white, one driver is required for each CCT - 2700 K and 5700 K.

Drop field 2x2: at least two luminaires must always be supplied together.

Drivers tuneable white

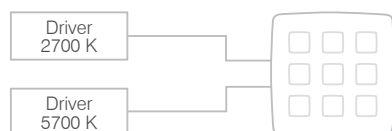

Drivers tuneable white
drop field 2x2

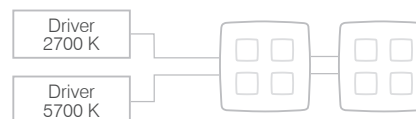

= max. Anzahl Leuchten pro Konverter
max. number of luminaires per driver
ET= erforderliche Einbautiefe der Leuchte in mm
required installation depth in mm
1 = Revisionsöffnung erforderlich
Revision opening required

Empfohlener Maximalabstand zwischen Leuchte und Konverter = 3.000 mm
Maximum recommended distance between luminaire and driver = 3.000 mm

Kabelbaum für steckbaren Anschluss von mehreren Leuchten auf Anfrage lieferbar
Wiring harness for plug-in connection of several luminaire on request

Optionales Zubehör Optional accessories

Einbaukanal Recessed channel

Gipsformteil zum bündigen Einbau in Gipskarton
Gypsum part for plasterboard ceiling

L = 2.000 mm

Code	65E	313020
	32E	325020

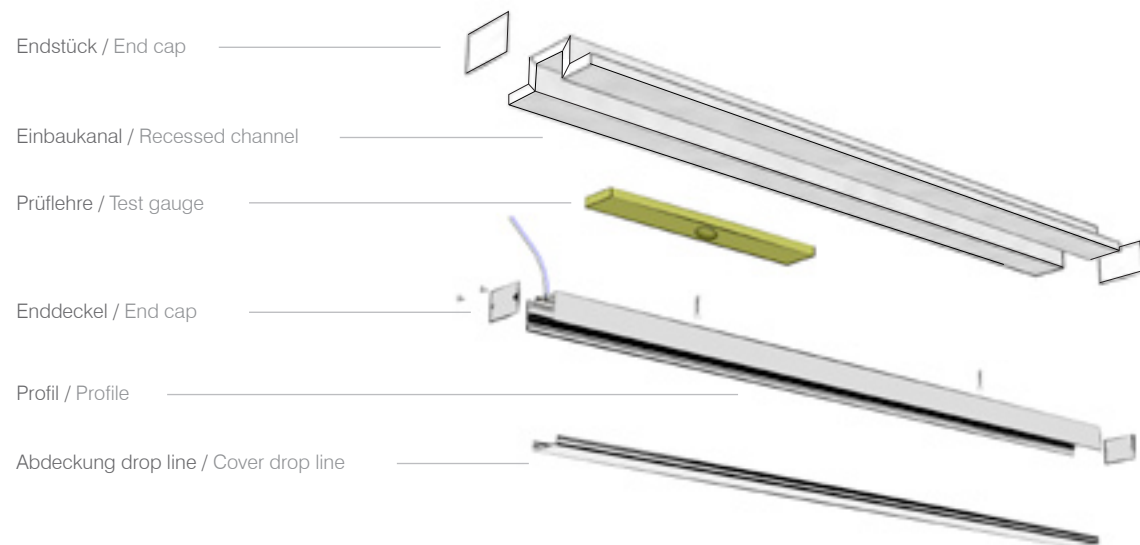
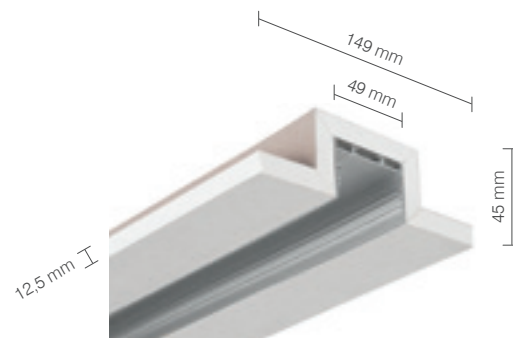

Installationshinweis drop line Pendel Mounting note drop line pendant

65P / 32P



32P+

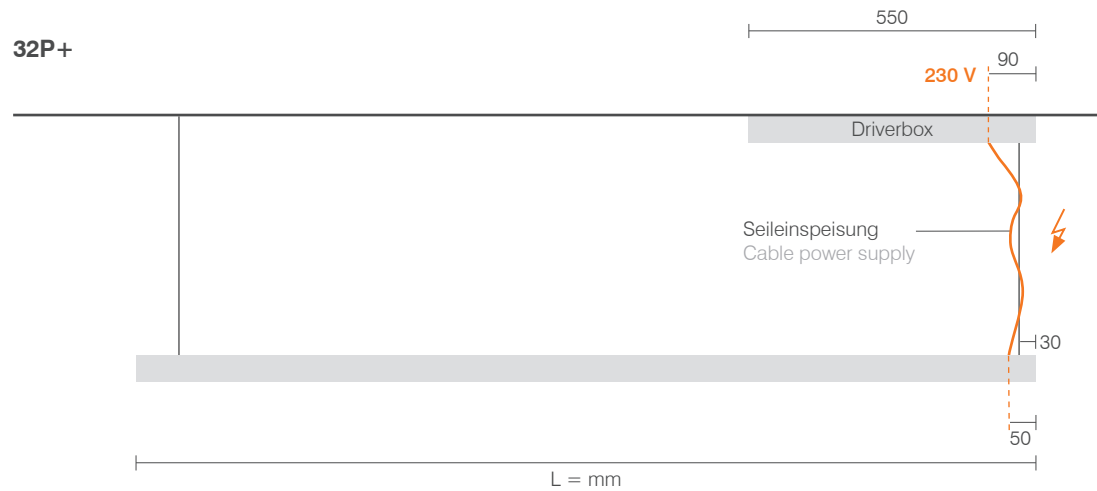

Legende Signs and symbols

K	Farbtemperatur / CCT
L=mm	Länge in Millimeter / Length in millimeters
#DOT	Anzahl Lichtpunkte / Number of light points
W	Leistung - Systemleistung ohne Gerät / Power - Systempower without lamp ballast
Im	Lichtstrom Platine / Luminous flux PCB
DA=mm	Deckenausschnitt in Millimeter / Ceiling cut out in millimeters
CODE	Artikelnummer / Code
ET=mm	Einbautiefe Leuchte in Millimeter / Installation depth luminaire in millimeters

1 = Code + D = DALI dimmbar / dimmable

Standard Oberflächen / Standard surfaces

- = aluminium eloxiert oder pulverbeschichtet grau bei drop field
aluminium anodized or powder-coated grey drop field
 - 5 = weiss (RAL 9016) / white
 - 6 = schwarz (RAL 9005) / black
 - 8 = dunkelbronze feingeschliffen / dark bronze brushed
 - 9 = edelstahl optik eloxiert / stainless steel finish
- RAL und NCS Farbpalette auf Anfrage / RAL and NCS colour on request

-  Richtlinien-Konformitätszeichen / CE conformity mark
-  Schutzklasse 3, SELV / Appliance class 3, SELV
-  Schutzklasse 2 / Appliance class 2
-  Schutzklasse 1 / Appliance class 1
- IP** IP Schutzart / IP protection class
-  Nicht mit Dämmmaterialien abdecken / Do not cover with insulation materials

made in Austria

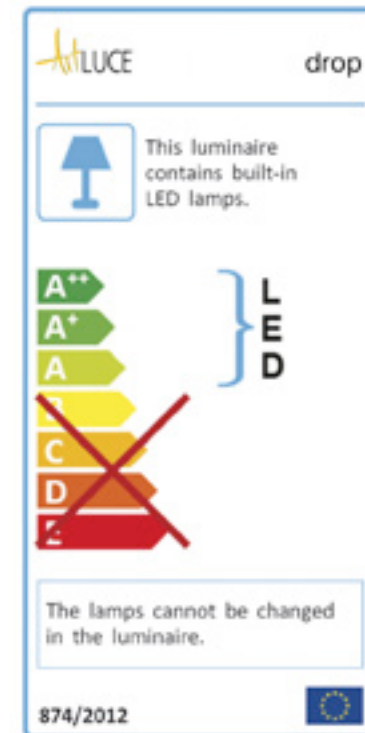

Code

drop line

Beispiel / Example:

drop line 32A, L=1.010, 3000 K, 45°, black, DALI

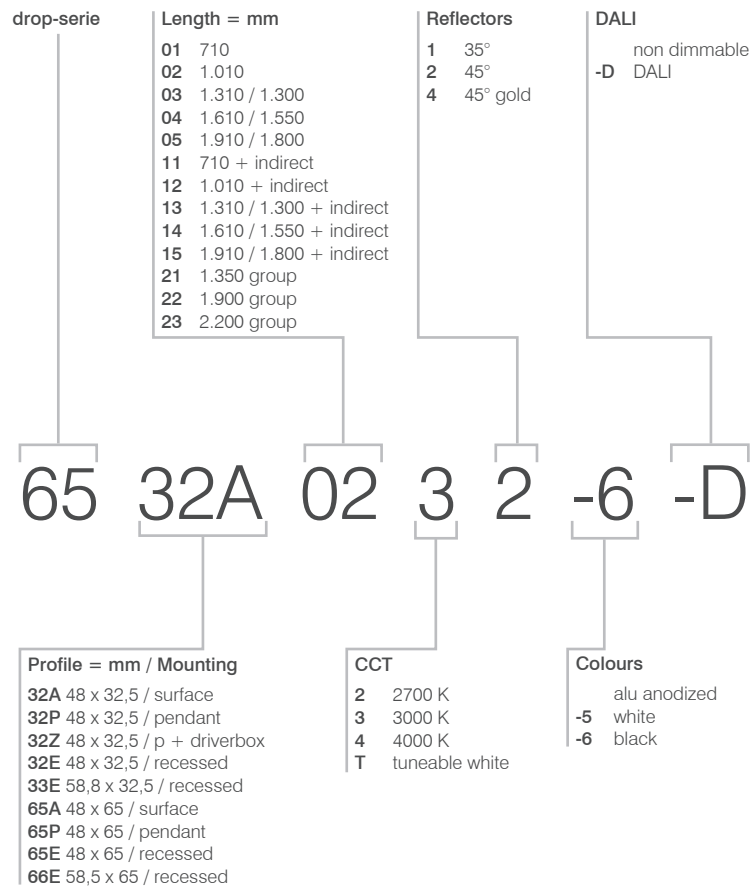

drop field / tiny drop

Beispiel / Example:

drop field 2x2 Q IP44, tuneable white, 45° gold, white

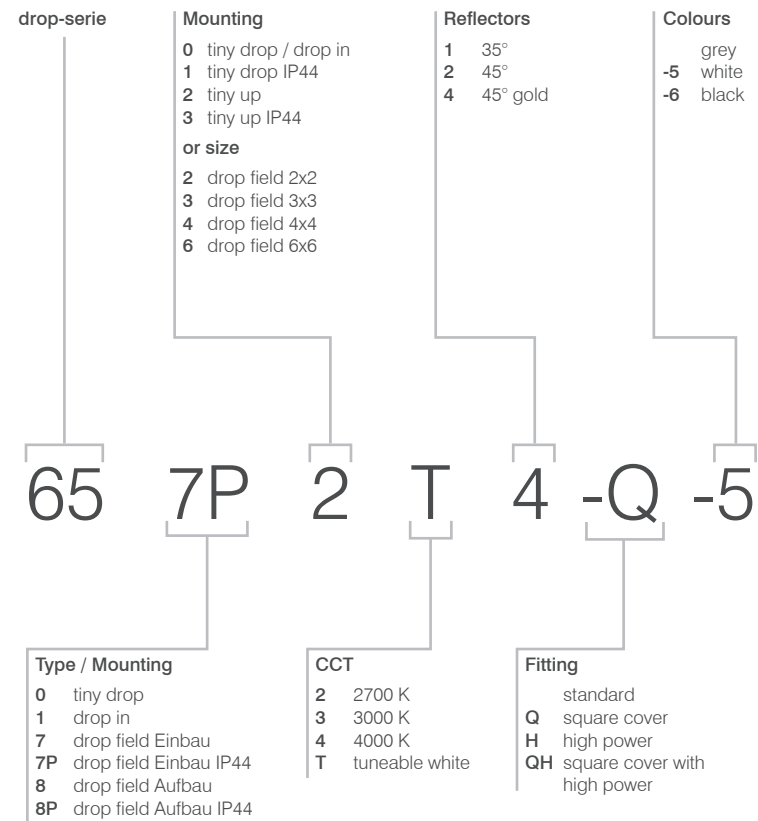

Produktänderungen, die dem technischen Fortschritt dienen, vorbehalten. Wir liefern ausschließlich nach unseren Allgemeinen Liefer- und Geschäftsbedingungen.
Product prices and technical specification are subject to change without prior notice. Our general terms and conditions of sales and delivery will apply to all offers and deliveries.

